

SN3000. 1/4

NAMUR Interface
Solenoid / Pneumatic Valves

- 5/2, 5/3 -1/4
- 23mm Body Width
- Transition Flow 1000ℓ/min (5bar)

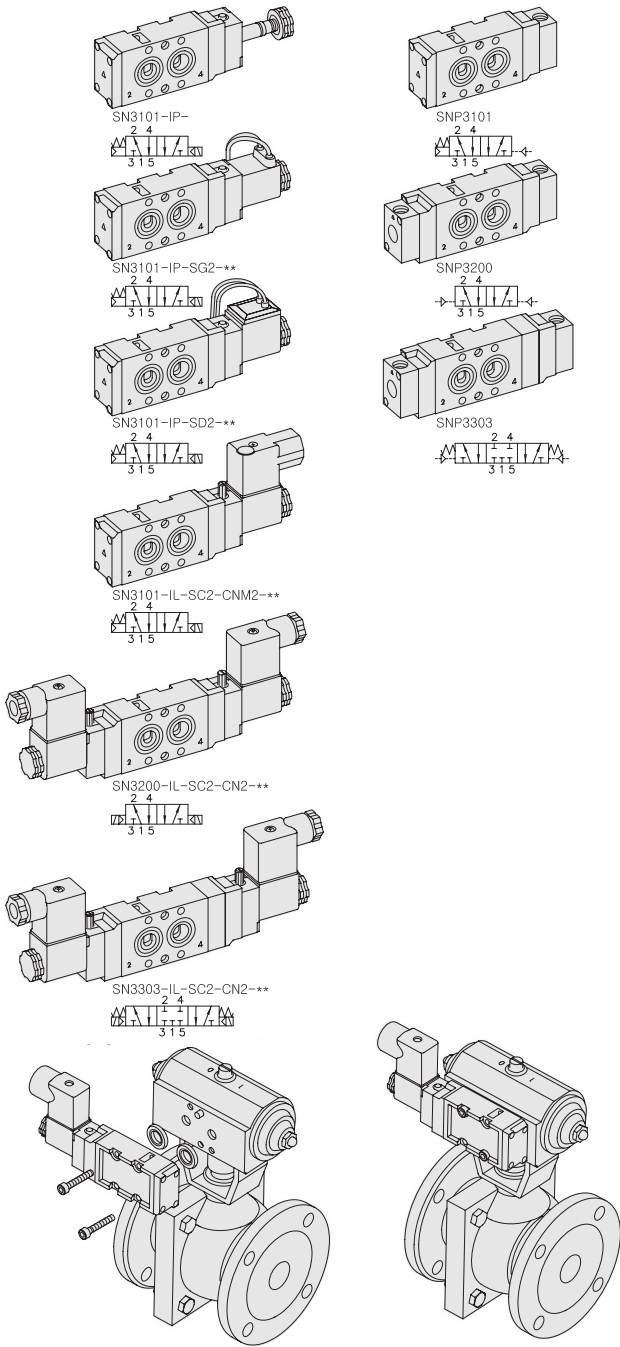

SPECIFICATION

ITEM	SERIES	SOLENOID, PNEUMATIC	
		5 Port 2 Position	5 Port 3 Position
Fluids		Compressed Air & Inert Gases	
Pressure(bar)		1.5~10.0	2.0~10.0
Eff. Sectional Area(mm ²)-5bar		18.0	12.0
Ambient & Fluid Temp.		5~60°C (41~140°F)	
Response Time(5bar)		30ms or Less	40ms or Less
Max. Working Frequency		5c/sec	3c/sec
Lubrication		Not Required(Use ISO VG32 #)	
Manual Override		Push Button(Standard), Lever Lock(Option)	
Coil Insulation Class		F-Class or Equivalent	
Permissible Voltage Variation		±10% of Rated Voltage	
Off Min. Residual Voltage		AC:20% or Less / DC:10% or Less	
Power Consumption		Holding-AC:5.5VA(60Hz) / DC:2.5W	

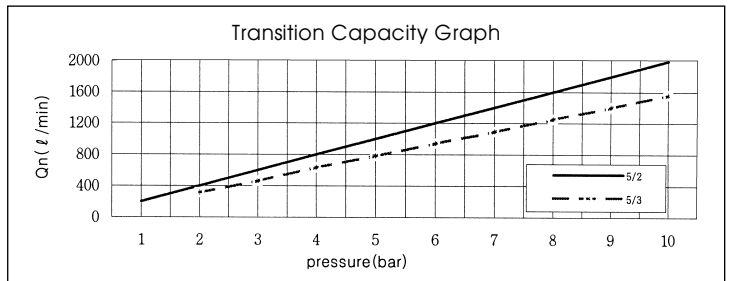

- ### The Material of Parts
- Valve Body : Die-Cast Aluminium
 - Spool : Aluminium
 - Seals : NBR
 - Spring : Stainless
 - Cap : Zinc Pressure Die-Cast
 - Pilot Parts : Glass Filled Nylon
 - Armature : Stainless Steel
 - Armature Seals : Viton

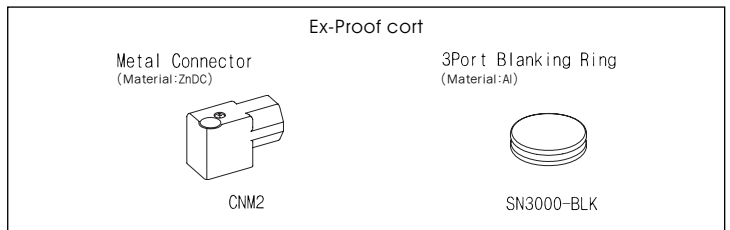

* The specification on each item can be amended without any prenotice to improve a performance.
* The specification on each item can be different from actual specification.

ORDERING NO.

SN3 1 0 1 - I P - SC2 - CN2 - A2

Valve Series	Function	Port Size & Thread	Return Method	Int/Ext. Pilot	Manual Operator	Solenoid Coil Type	Connector Type	Voltage
SN3 : Solenoid Valve	1 5/2 Single	0 G 1/4	0 None	I Internal Pilot	0 None	0 None	0 None	0 None
	2 5/2 Double	1 NPT 1/4	1 Air + Spring		P Push	SC2 3 Pin Connector Coil	CN2 Normal Connector	A2 AC 220V
	3 5/3 Closed Center		2 Air		Non-Locking	SG2 Grommet/Flying Leads	CD2 Connector With LED	A1 AC 110V
	4 5/3 Open Center		3 Spring		L Lever Locking	SD2 Grommet/Flying Leads With LED	C22 Connector With LED & Surge Suppressor	A4 AC 24V D4 DC 24V
SNP3 : Pneumatic Valve	5 5/3 Pressure Center						CNM2 Metal Connector	D2 DC 12V
							CDM2 Metal Connector With LED	
							C2M2 Metal Connector With LED & Surge Suppressor	

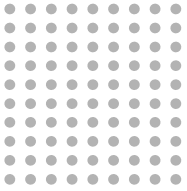

Solenoid & Pilot Actuated Spool Valves

5Port 2Position Solenoid Valve

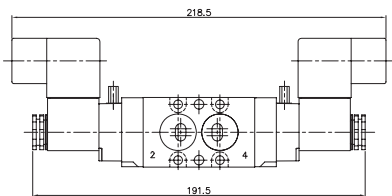
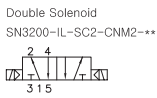
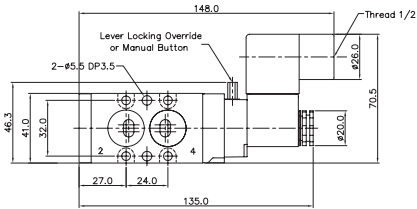
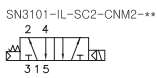
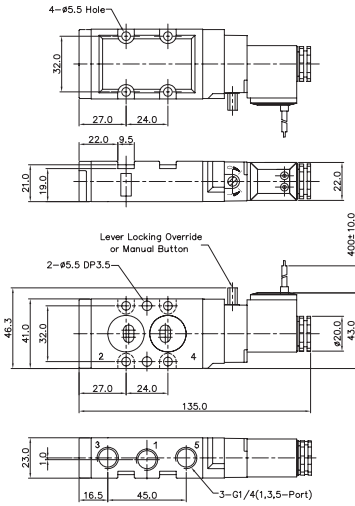
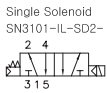

5Port 3Position Solenoid Valve

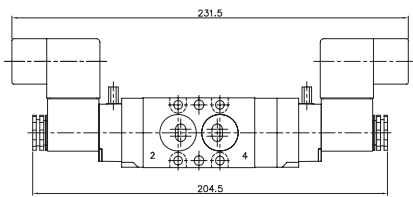
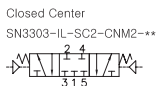

5Port 2Position Pneumatic Valve

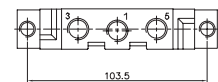
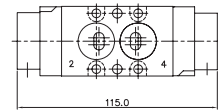
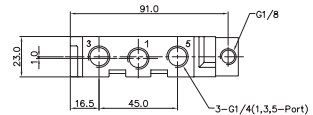
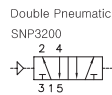
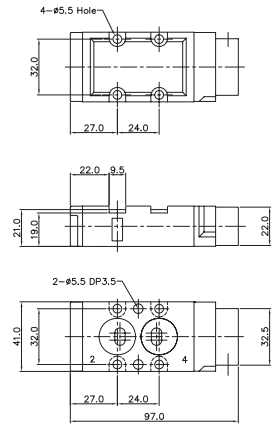
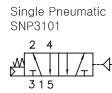

5Port 3Position Pneumatic Valve

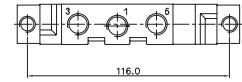
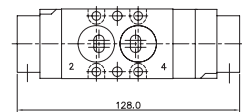

Sealing Part Dimension

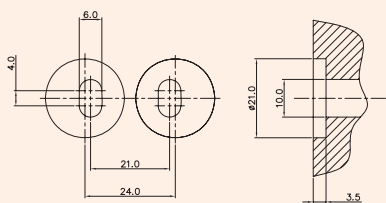

Sealing Area

3-Port Blanking Part (Material : Al)

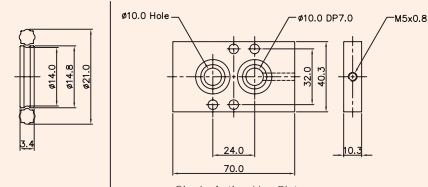

SN3000-BLK

Single Acting Use Plate
 SN3000-Plate

Metal Connector (Material : ZnDC)

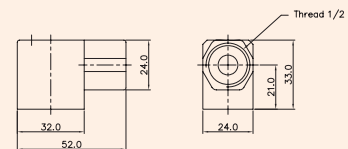

CNM2